

① TOP VIEW

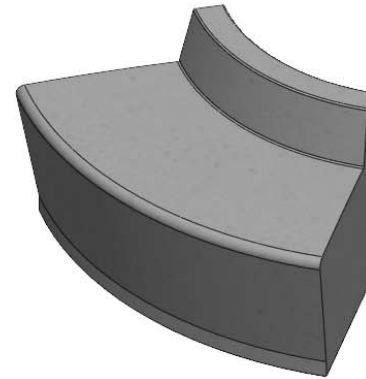

④ ISO

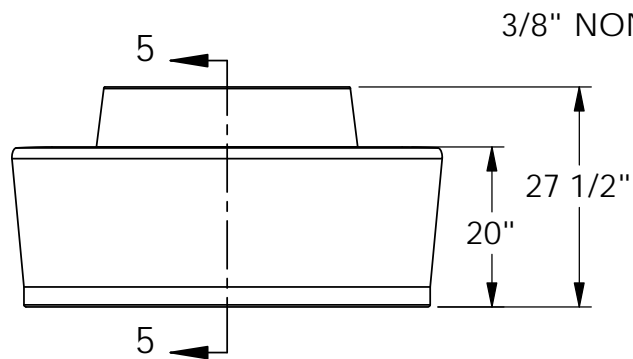

② FRONT VIEW

3/8" NON COATED REBAR; TYP.

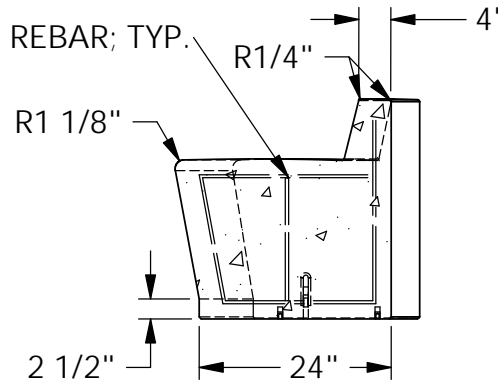

⑤ SECTION

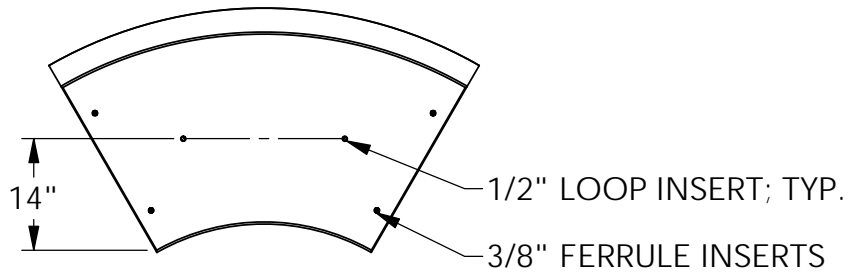

③ BOTTOM VIEW



WAUSAU TILE

P.O. BOX 1520, WAUSAU, WI 54402-1520
800-388-8728
EMAIL: WTILE@WAUSAUTILE.COM
WEBSITE: WWW.WAUSAUTILE.COM

REVISIONS

	BY	DATE	NOTE
1	-		-
2	-		-
3	-		-
4	-		-
5			

CONFIDENTIAL INFORMATION

THESE DRAWINGS, SPECIFICATIONS AND OTHER INFORMATION AND DOCUMENTS ACCOMPANYING THEM ARE THE CONFIDENTIAL AND PROPRIETARY PROPERTY OF WAUSAU TILE, INC. THE DRAWINGS THEMSELVES SHALL BELONG TO THE OWNER FOR USE ONLY ON THE PROJECT. ANY ADDITIONAL USE SHALL REQUIRE THE PRIOR WRITTEN APPROVAL OF WAUSAU TILE, INC. THE PROPRIETARY INFORMATION CONTAINED WITHIN THE DRAWINGS AND THE DOCUMENTS IS AND SHALL REMAIN THE SOLE PROPERTY OF WAUSAU TILE, INC.

UNLESS OTHERWISE SPECIFIED DIMENSIONS SHOWN ARE ROUNDED TO THE CLOSEST FRACTION ± 1/16"

DRAWING SCALE: NOT TO SCALE

FABRICATION TOLERANCE: ± 1/8"

WOODLINE

DRAWN BY: BMP DATE: 7/26/2022

CO NUMBER: -

WEIGHT: 1921

PRODUCT NUMBER:

ZB.WL.31