

① TOP VIEW

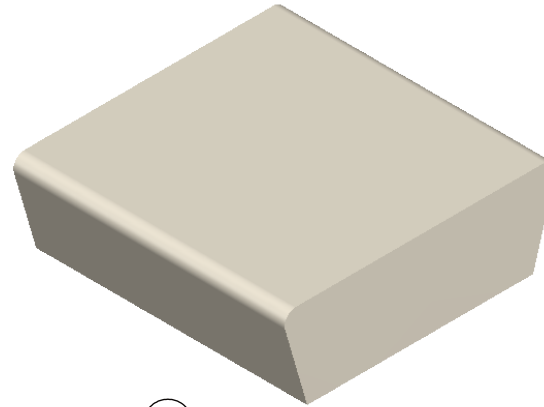

④ ISO

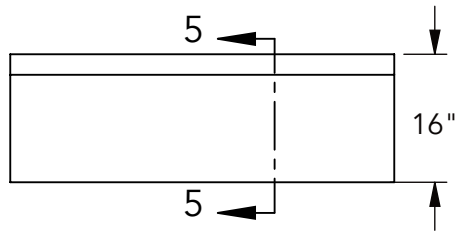

② FRONT VIEW

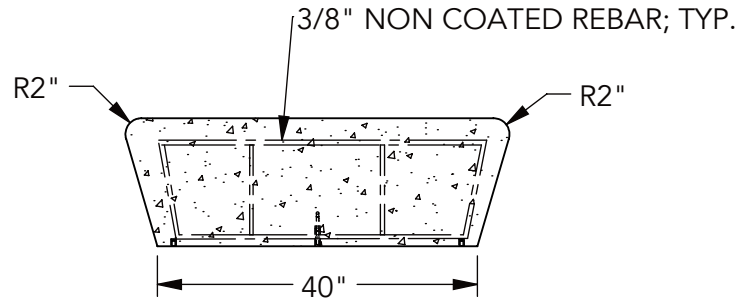

⑤ SECTION

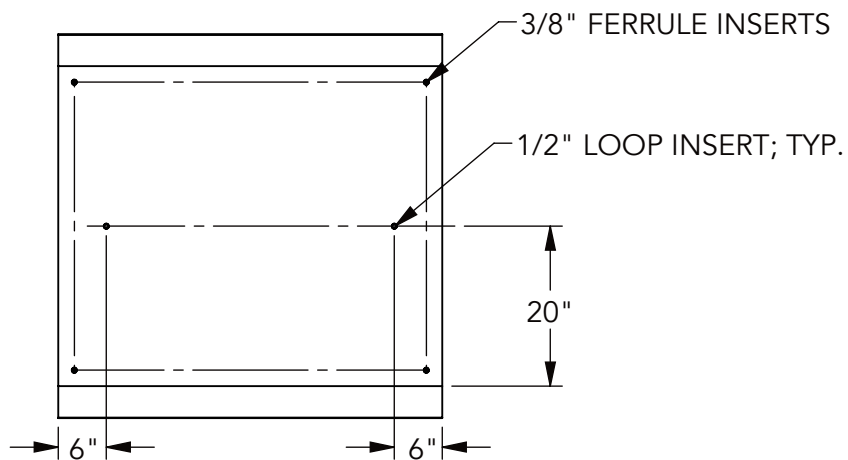

③ BOTTOM VIEW



WAUSAU TILE

P.O. BOX 1520, WAUSAU, WI 54402-1520
 800-388-8728
 EMAIL: WTILE@WAUSAUTILE.COM
 WEBSITE: WWW.WAUSAUTILE.COM

REVISIONS

	BY	DATE	NOTE
1	-		-
2	-		-
3	-		-
4	-		-
5			

CONFIDENTIAL INFORMATION
 THESE DRAWINGS, SPECIFICATIONS AND OTHER INFORMATION AND DOCUMENTS ACCOMPANYING THEM ARE THE CONFIDENTIAL AND PROPRIETARY PROPERTY OF WAUSAU TILE, INC. THE DRAWINGS THEMSELVES SHALL BELONG TO THE OWNER FOR USE ONLY ON THE PROJECT. ANY ADDITIONAL USE SHALL REQUIRE THE PRIOR WRITTEN APPROVAL OF WAUSAU TILE, INC. THE PROPRIETARY INFORMATION CONTAINED WITHIN THE DRAWINGS AND THE DOCUMENTS IS AND SHALL REMAIN THE SOLE PROPERTY OF WAUSAU TILE, INC.

UNLESS OTHERWISE SPECIFIED DIMENSIONS SHOWN ARE ROUNDED TO THE CLOSEST FRACTION ± 1/16"

DRAWING SCALE: NOT TO SCALE

FABRICATION TOLERANCE: ± 1/8"

CENTENAIRE

DRAWN BY: SKD DATE: 7/29/2020

CO NUMBER: -

WEIGHT: 2,971 LBS

PRODUCT NUMBER: ZB.CE.12