

REVISION

	DRAWN BY	DATE	NOTES
1			
2			
3			
4			
5			
6			
7			

CONFIDENTIAL INFORMATION
 THESE DRAWING, SPECIFICATIONS AND
 OTHER INFORMATION AND DOCUMENTS
 ACCOMPANYING THEM ARE THE
 CONFIDENTIAL AND PROPRIETARY PROPERTY
 OF WAUSAU TILE, INC. THE DRAWINGS
 THEMSELVES SHALL BELONG TO THE
 OWNER FOR USE ONLY ON THE PROJECT.
 ANY ADDITIONAL USE SHALL REQUIRE THE
 PRIOR WRITTEN APPROVAL OF WAUSAU
 TILE, INC. THE PROPRIETARY INFORMATION
 CONTAINED WITHIN THE DRAWINGS AND THE
 DOCUMENTS IS AND SHALL REMAIN THE
 SOLE PROPERTY OF WAUSAU TILE, INC

JOB NAME

LOCATION

UNLESS OTHERWISE SPECIFIED
 DIMENSIONS ARE IN INCHES
 FRACTIONS ± 1/8"

DRAWN BY: JPZ

DATE: 1/5/14

CO NUMBER:

WEIGHT: 950 LBS.

SHEET NO.

TF3123

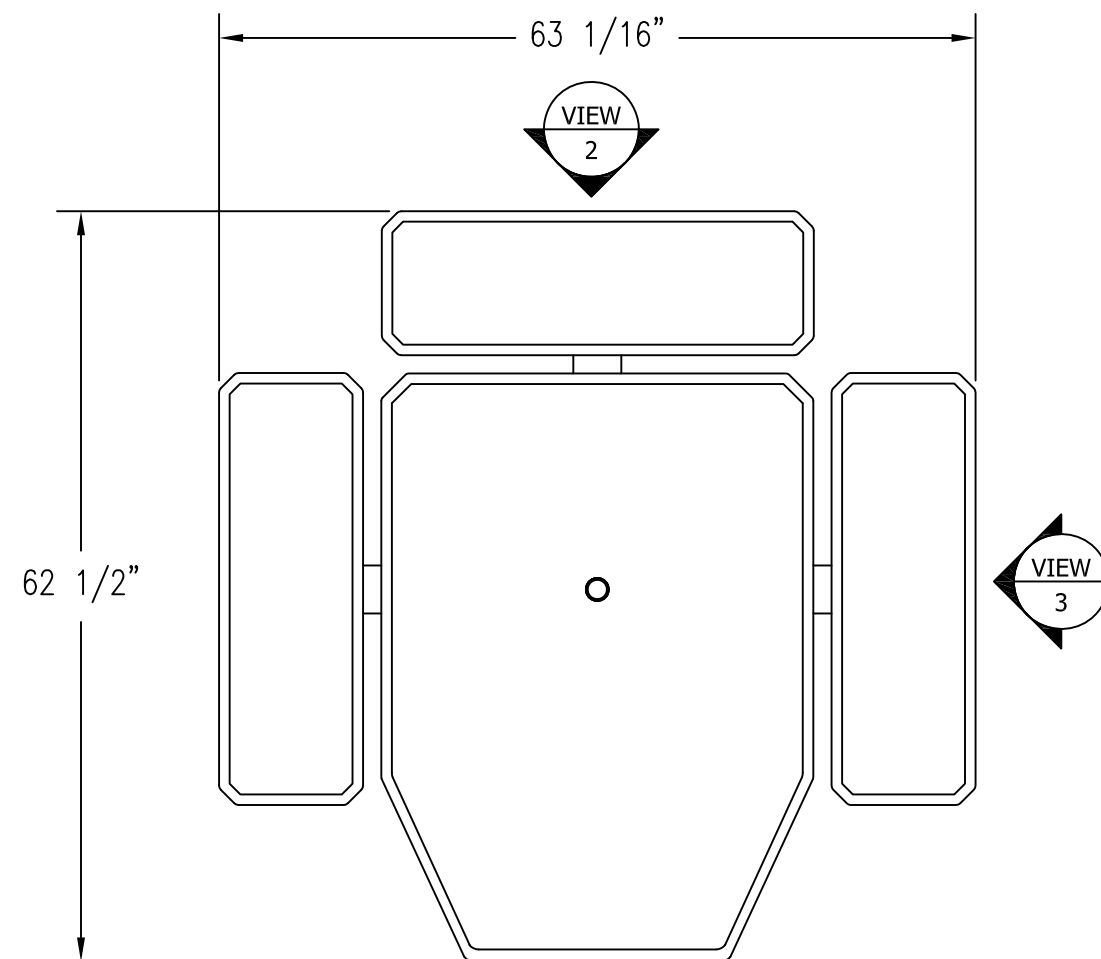

1 TOP VIEW
 Scale: 1/16" = 1"

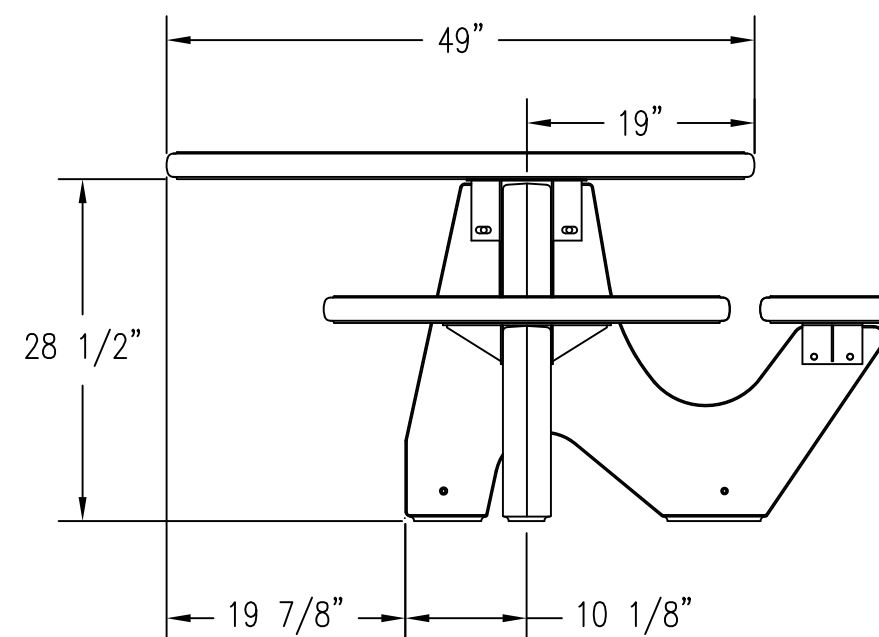

3 ELEVATION VIEW
 Scale: 1/16" = 1"

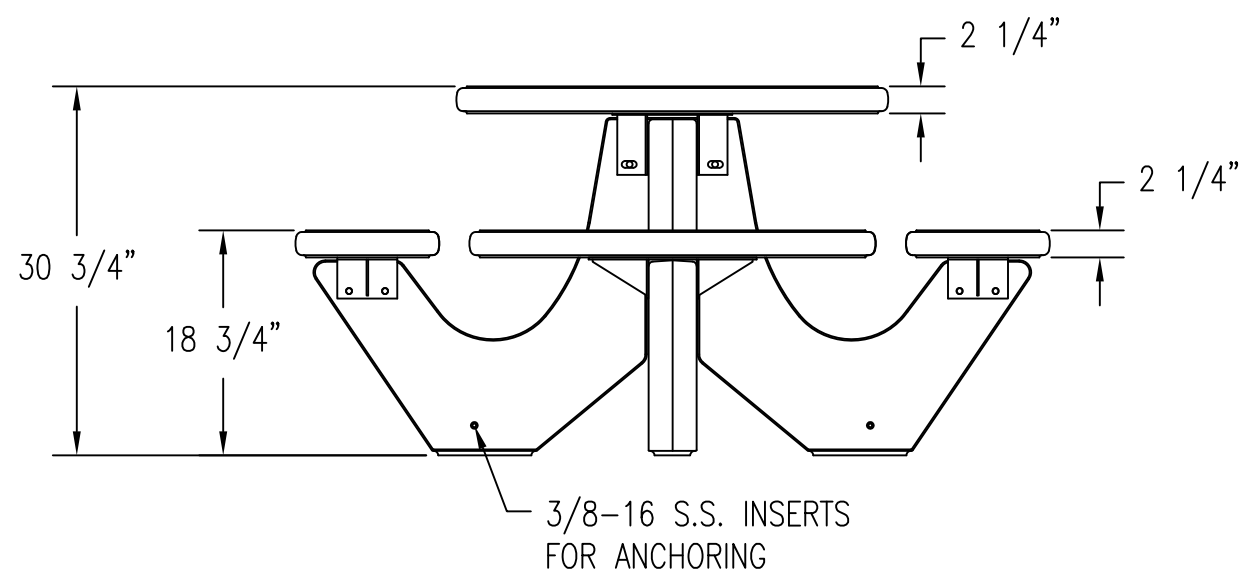

2 ELEVATION VIEW
 Scale: 1/16" = 1"