

IN & OUT BENCH

Elements	Length inch	Width inch	Height inch	Weight lbs/p
ZB.IO.01	91 7/16	34	32	3,661
ZB.IO.02	98 7/8	23 1/4	24	1,927
ZB.IO.03	98 7/8	23 1/4	24	1,944
ZB.IO.04	91 7/16	34	32	3,546

! Special custom manufacturing. Order and delivery time on request

Shape

Basic element

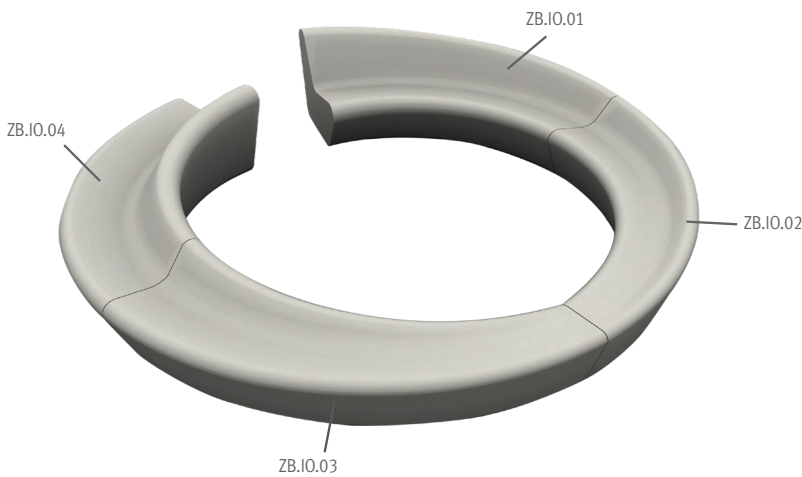

Product description

Characteristics

- Prefabricated concrete element
- Finish:
 - > Acid wash : a light acid etch finish with an even and flat texture across the entire surface
 - > Weatherstone : a sandblast finish exposing rock and giving a subtle texture and weathered look
- Hidden anchoring

Delivery information

- Delivery only on pallets

Project study information

- Specific dimensions in custom manufacturing (only on order): on demand

Shipping fees

- On demand

Colors*

Acid wash

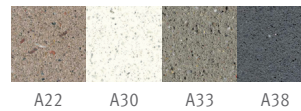

Weatherstone

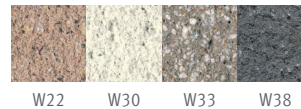

* Additional colors available on WausauTile.com

Designer

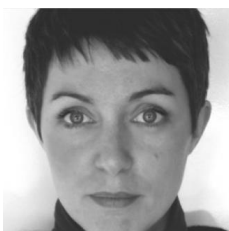

Lucile Souflet

Accessories for this product



- Skatestoppers
- Armrests



IN & OUT BENCH

Shape

Basic element

ZB.10.01

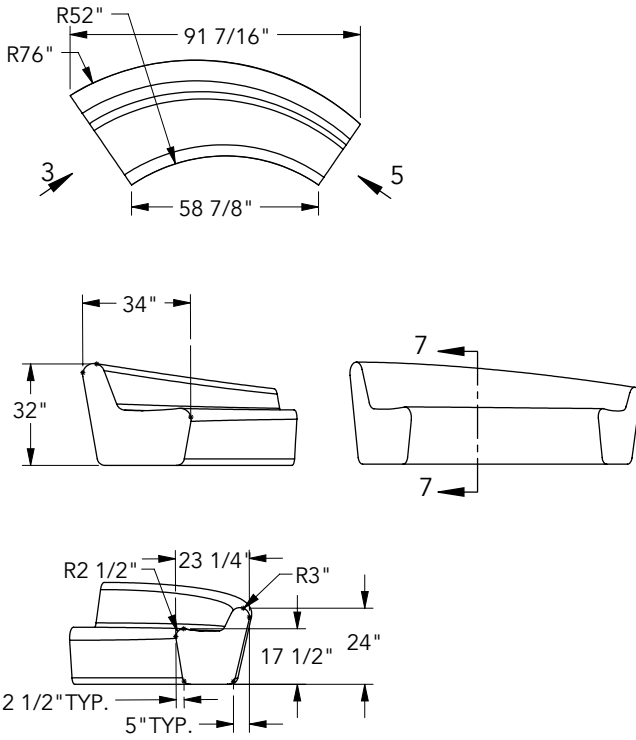

ZB.10.02

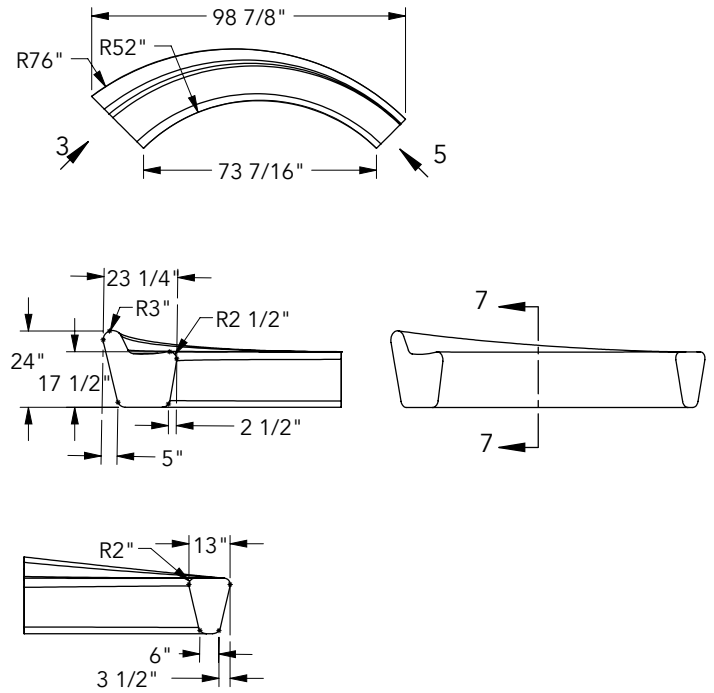

Handling

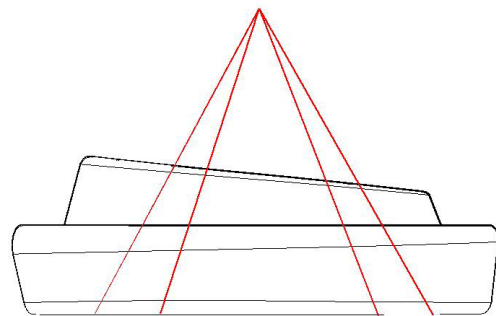
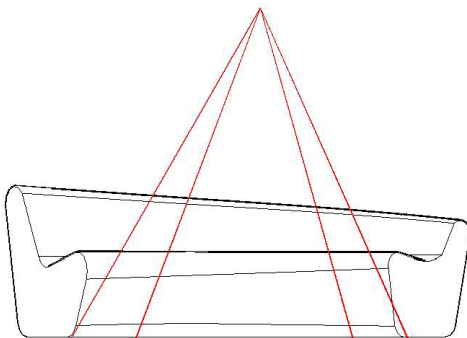



IN & OUT BENCH

Shape

Basic element

ZB.10.03

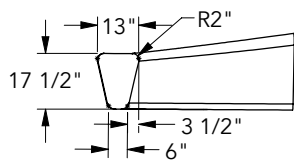
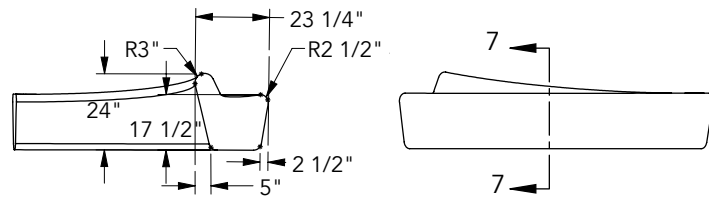
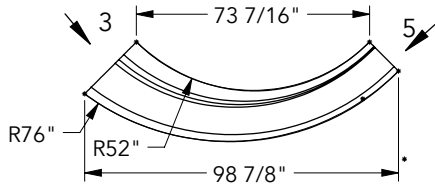

ZB.10.04

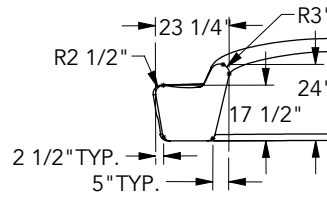
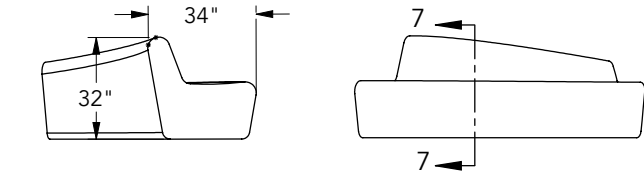
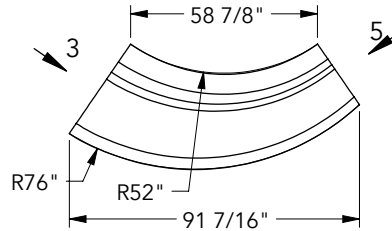

Handling

