

GALET | BENCH

Elements	Length inch	Width inch	Height inch	Weight lbs/p
ZB.GL.01	50	50	16	2,381

! Special custom manufacturing. Order and delivery time on request

Shape

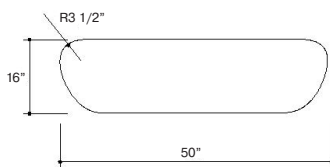
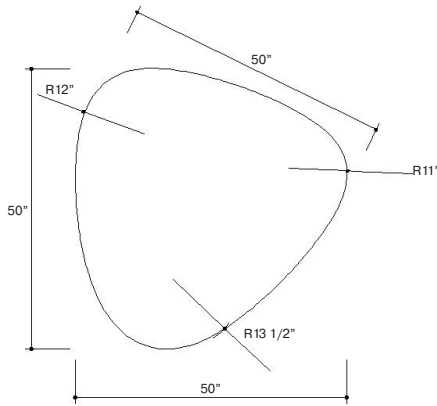
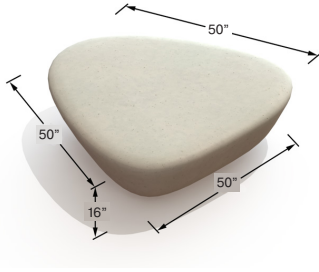

Handling

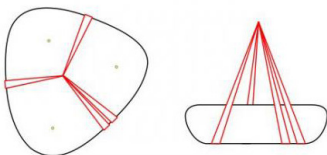

Designers



L'Escout Architecture

Product description

Characteristics

- Prefabricated concrete element
- Finish:
 - > Ground & polished: a flat, smooth and polished surface with exposed rock and matrix
 - > Acid wash : a light acid etch finish with an even and flat texture across the entire surface
 - > Weatherstone : a sandblast finish exposing rock and giving a subtle texture and weathered look
- Hidden anchoring

Delivery information

- Delivery only on pallets

Project study information

- Specific dimensions in custom manufacturing (only on order): on demand

Shipping fees

- On demand

Colors*

Ground & polished

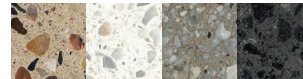

Acid wash

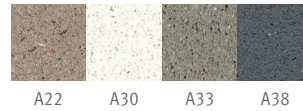

Weatherstone

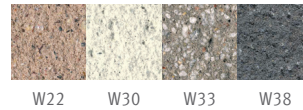

* Additional colors available on WausauTile.com



GALET II BENCH

Elements	Length inch	Width inch	Height inch	Weight lbs/p
ZB.GL.02	63	63	19 1/2	4,121

! Special custom manufacturing. Order and delivery time on request

Shape

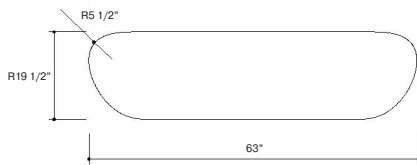
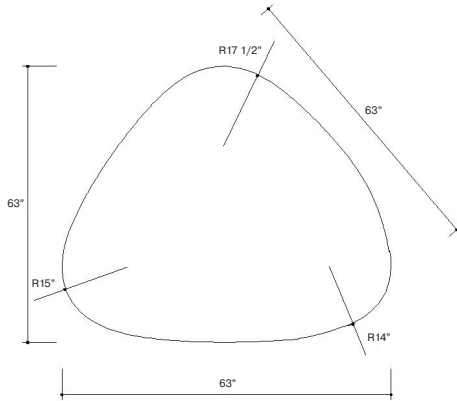
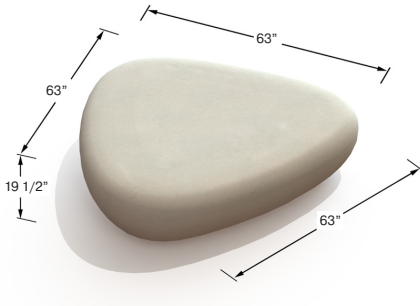

Handling

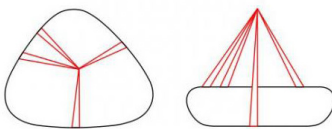

Designers



L'Escaut Architecture

Product description

Characteristics

- Prefabricated concrete element
- Finish:
 - > Ground & polished: a flat, smooth and polished surface with exposed rock and matrix
 - > Acid wash : a light acid etch finish with an even and flat texture across the entire surface
 - > Weatherstone : a sandblast finish exposing rock and giving a subtle texture and weathered look
- Hidden anchoring

Delivery information

- Delivery only on pallets

Project study information

- Specific dimensions in custom manufacturing (only on order): on demand

Shipping fees

- On demand

Colors*

Ground & polished



Acid wash

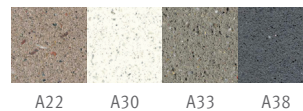

Weatherstone

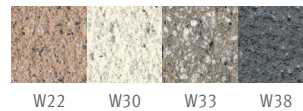

* Additional colors available on WausauTile.com



GALET III BENCH

Elements	Length inch	Width inch	Height inch	Weight lbs/p
ZB.GL.03	94	52	17	5,058

! Special custom manufacturing. Order and delivery time on request

Shape

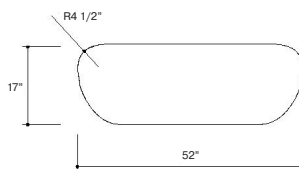
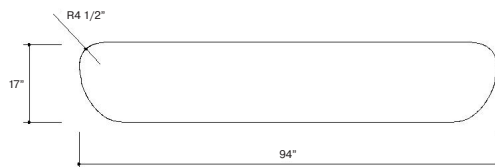
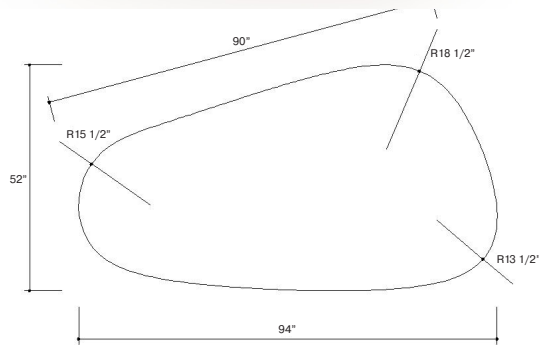
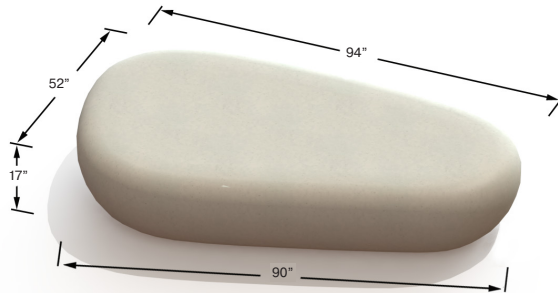

Handling

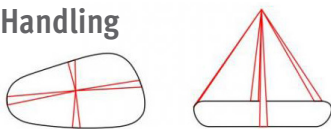

Designers



L'Escaut Architecture

Product description

Characteristics

- Prefabricated concrete element
- Finish:
 - > Ground & polished: a flat, smooth and polished surface with exposed rock and matrix
 - > Acid wash : a light acid etch finish with an even and flat texture across the entire surface
 - > Weatherstone : a sandblast finish exposing rock and giving a subtle texture and weathered look
- Hidden anchoring

Delivery information

- Delivery only on pallets

Project study information

- Specific dimensions in custom manufacturing (only on order): on demand

Shipping fees

- On demand

Colors*

Ground & polished

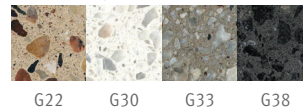

Acid wash

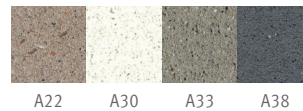

Weatherstone

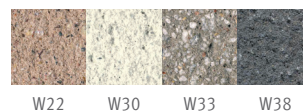

* Additional colors available on WausauTile.com





GALET IV BENCH

Elements	Length inch	Width inch	Height inch	Weight lbs/p
ZB.GL.04	96	70	17	7,329

! Special custom manufacturing. Order and delivery time on request

Shape

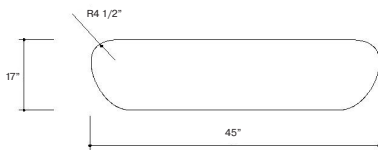
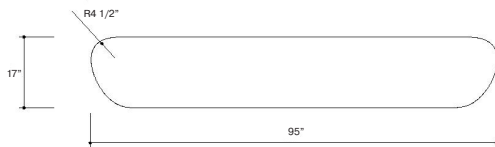
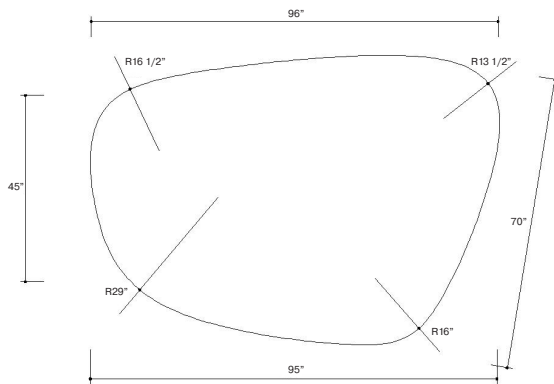
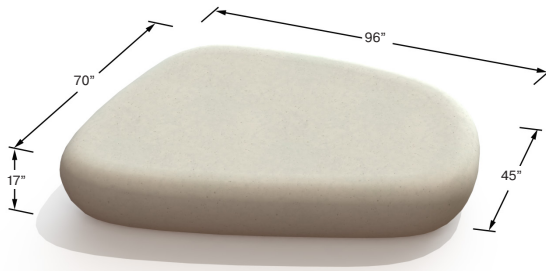

Handling

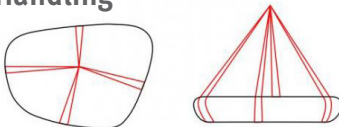

Designers



L'Escaut Architecture

Product description

Characteristics

- Prefabricated concrete element
- Finish:
 - > Ground & polished: a flat, smooth and polished surface with exposed rock and matrix
 - > Acid wash : a light acid etch finish with an even and flat texture across the entire surface
 - > Weatherstone : a sandblast finish exposing rock and giving a subtle texture and weathered look
- Hidden anchoring

Delivery information

- Delivery only on pallets

Project study information

- Specific dimensions in custom manufacturing (only on order): on demand

Shipping fees

- On demand

Colors*

Ground & polished



Acid wash

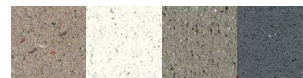

Weatherstone

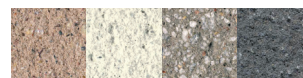

* Additional colors available on WausauTile.com



GALET V BENCH

Elements	Length inch	Width inch	Height inch	Weight lbs/p
ZB.GL.05	120	84	14	5,377

! Special custom manufacturing. Order and delivery time on request

Shape

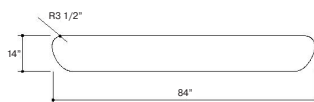
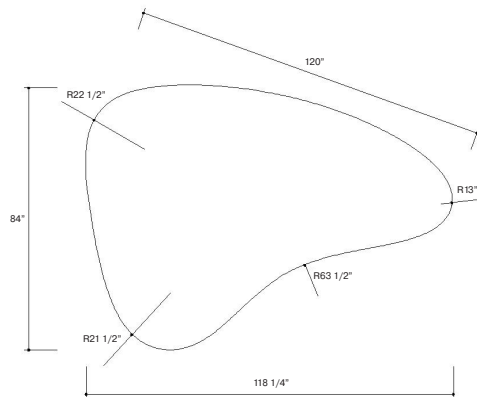
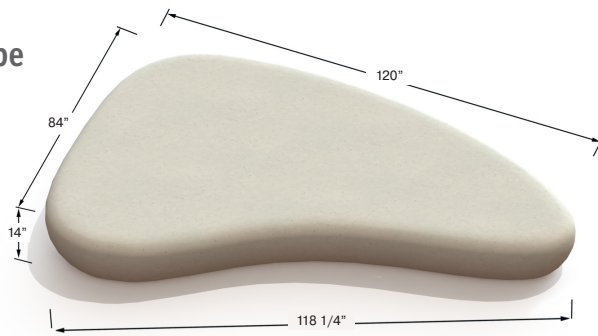

Handling

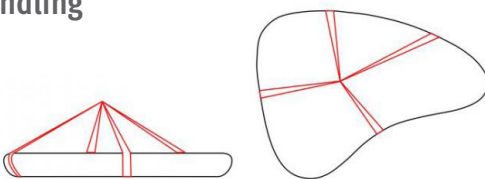

Designers



L'Escaut Architecture

Product description

Characteristics

- Prefabricated concrete element
- Finish:
 - > Ground & polished: a flat, smooth and polished surface with exposed rock and matrix
 - > Acid wash : a light acid etch finish with an even and flat texture across the entire surface
 - > Weatherstone : a sandblast finish exposing rock and giving a subtle texture and weathered look
- Hidden anchoring

Delivery information

- Delivery only on pallets

Project study information

- Specific dimensions in custom manufacturing (only on order): on demand

Shipping fees

- On demand

Colors*

Ground & polished

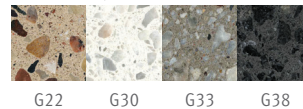

Acid wash

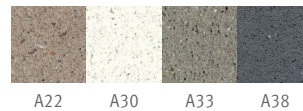

Weatherstone

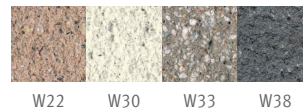

* Additional colors available on WausauTile.com





GALET VI BENCH

Elements	Length inch	Width inch	Height inch	Weight lbs/p
ZB.GL.o6	72	72	17 1/2	3,750

! Special custom manufacturing. Order and delivery time on request

Shape

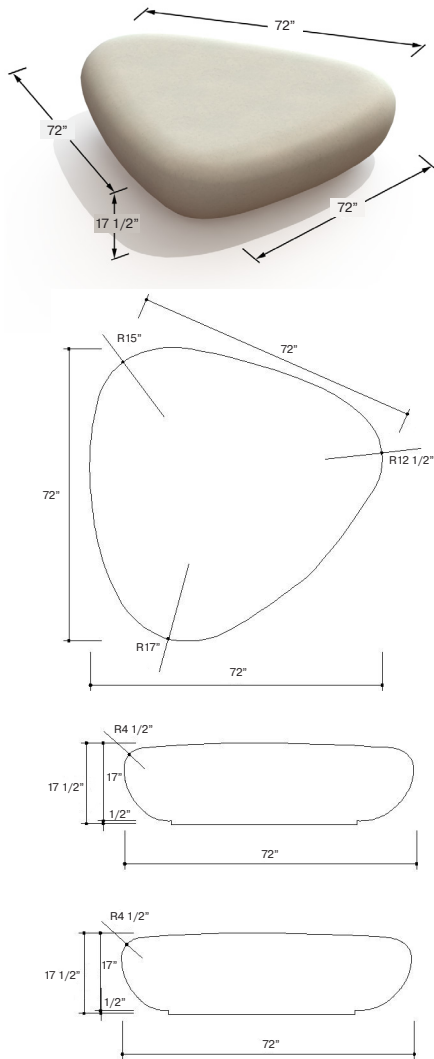

Handling

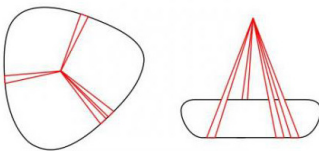

Designers



L'Escaut Architecture

Product description

Characteristics

- Prefabricated concrete element
- Finish:
 - > Ground & polished: a flat, smooth and polished surface with exposed rock and matrix
 - > Acid wash : a light acid etch finish with an even and flat texture across the entire surface
 - > Weatherstone : a sandblast finish exposing rock and giving a subtle texture and weathered look
- Hidden anchoring

Delivery information

- Delivery only on pallets

Project study information

- Specific dimensions in custom manufacturing (only on order): on demand

Shipping fees

- On demand

Colors*

Ground & polished

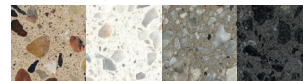

Acid wash

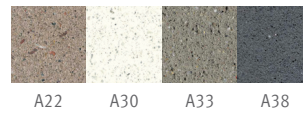

Weatherstone

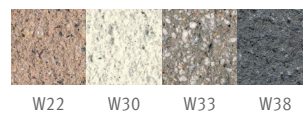

* Additional colors available on WausauTile.com

