

**1** TOP VIEW  
Scale: 1/8" = 1"

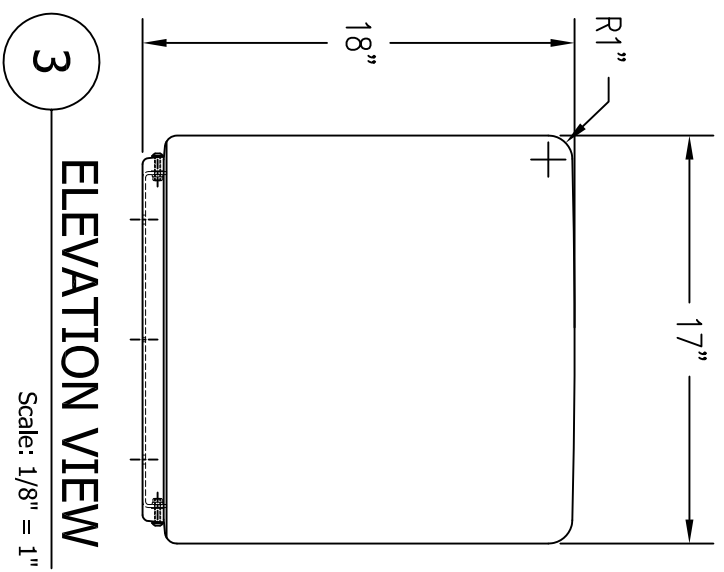

**3** ELEVATION VIEW  
Scale: 1/8" = 1"

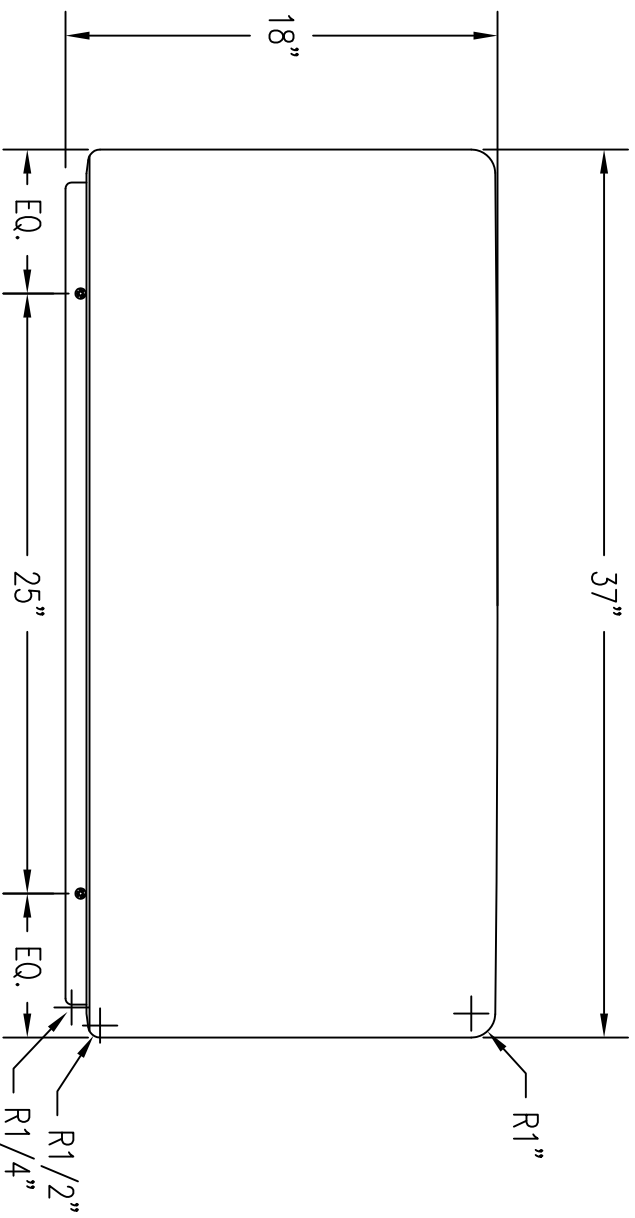

**2** ELEVATION VIEW  
Scale: 1/8" = 1"

REVISION	DESCRIPTION	DRAWN BY	DATE
1			
2			
3			
4			

<b>WAUSAU TILE</b>		P.O. BOX 1520 WAUSAU, WISCONSIN 54402-1520 800/388-8728	
DRAWN BY JPZ		P.O. BOX 967 BANNING, CALIFORNIA 92220 877/849-5696	
JOB NO.	JOB	LOCATION	MATERIAL PLASTIC
SCALE AS NOTED	UNLESS OTHERWISE SPECIFIED DIMENSIONS ARE IN INCHES TOLERANCES: ±1/8"		WEIGHT
FINISH OPTIONS	DATE 6/10/11	ITEM NO. 2402	DWG. NO. 1 OF 1