



# WAUSAU TILE LOK-DOWN SYSTEM

## TECHNICAL ADVANTAGES

- Paver thicknesses from 2" – 2 3/4" thick
- Tested to withstand wind speeds of more than 145 mph
- Custom surfaces and textures are available
- 7 different bolt and cap colors to chose from

## STANDARD SIZES

Pavers available in thickness ranging from 2" - 2 3/4" depending on paver size.

### SQUARES



30" sq.



24" sq.

### RECTANGLES



24" x 48"

## TECHNICAL INFORMATION

PROPERTY	ADVANCED TESTING VALUE	TEST METHOD
Compressive Strength	> 8,000 PSI avg. with no individual unit less than 7,500 PSI	ASTM C 140
Water Absorption	<6%	ASTM C 140
Flexural Strength	> 1,200 pound average	ASTM C 140
Freeze/Thaw	< 1% loss of dry weight (50 cycles)	ASTM C 1262
Center Load	1,850 lbs.	WTCL 99

*Testing based on 24"x24"x2" pressed paver*

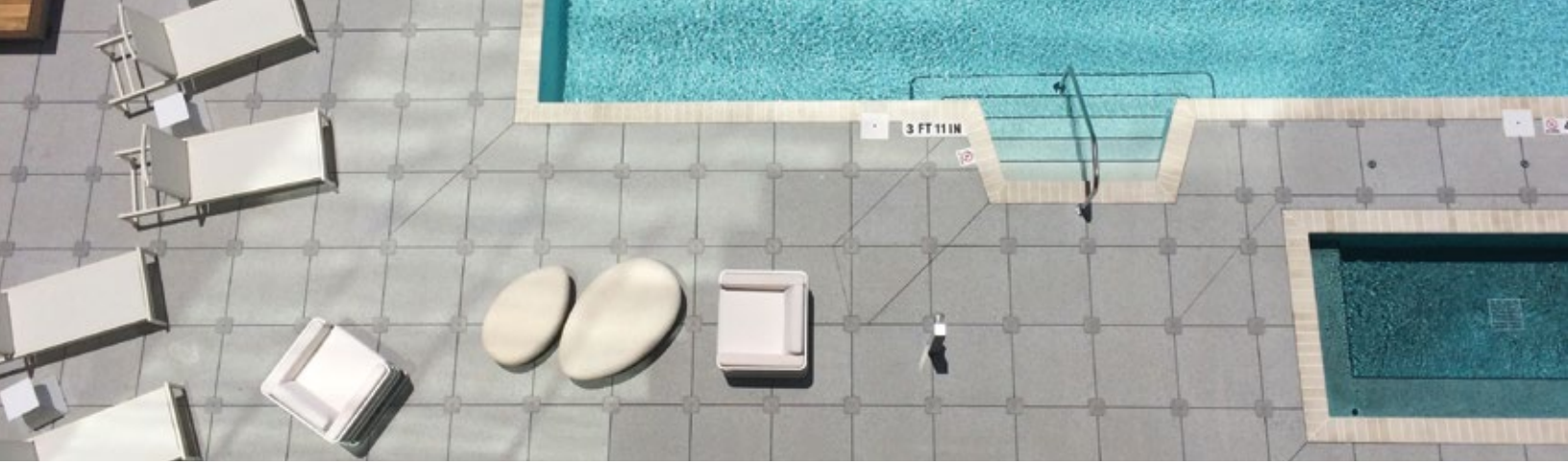

## LOK-DOWN SYSTEM CAP COLORS

Custom colors available in top plate and screw.



LD\_10 Cream   LD\_20 Tan   LD\_30 Gray   LD\_40 Brown   LD\_50 Red   LD\_60 Black   LD\_White

## BLASTED GLASS

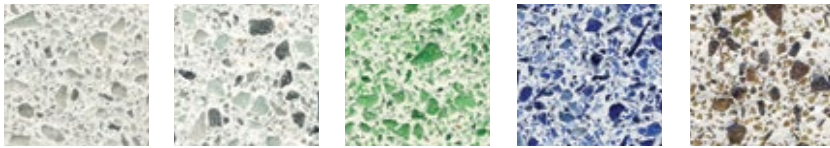

BG-10   BG-20   BG-30   BG-40   BG-50  
 \*\*64   \*\*53   \*\*58   \*\*37

## ECOPREMIER



EP-10   EP-20   EP-30   EP-40   EP-50   EP-60   EP-70  
 \*\*32   \*\*31   \*\*78   \*\*33   \*\*25   \*\*28   \*\*31

## EXPRESSIONS

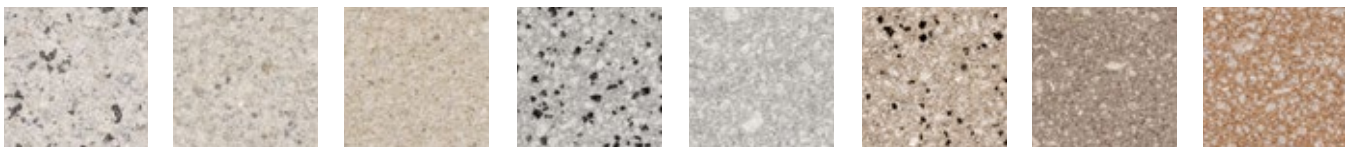

XP-10   XP-20   XP-30   XP-40   XP-50   XP-60   XP-70   XP-80  
 \*\*58   \*\*65   \*\*72   \*\*42   \*\*46   \*\*48   \*\*52   \*\*46

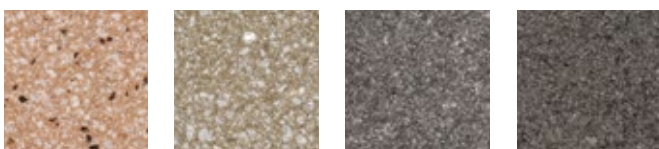

XP-90   XP-100   XP-110   XP-120  
 \*\*40

\*\*SRI

## EXTERIOR TERRAZZO

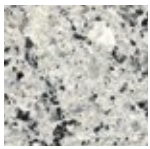

\*ET-10  
\*\*40



\*ET-20  
\*\*38



\*ET-30  
\*\*41

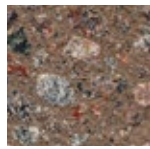

\*ET-40

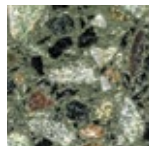

\*ET-50

Pavers available in thickness ranging from 2" - 2 7/8" depending on the size.

\*Sealed

## OCEAN VIEW

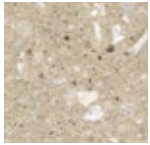

\*SEA-10  
\*\*56

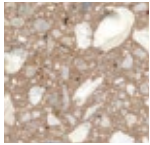

\*SEA-20  
\*\*53

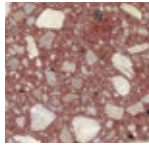

\*SEA-30

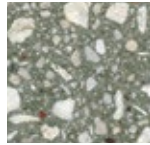

\*SEA-40

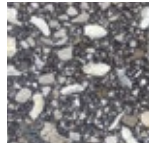

\*SEA-50

Pavers available in thickness ranging from 2" - 2 7/8" depending on the size.

\*Sealed

## SAND SERIES



SS-10  
\*\*34



SS-20  
\*\*25

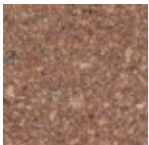

SS-30  
\*\*25



SS-40

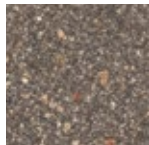

SS-50

## SERIES SESTO™

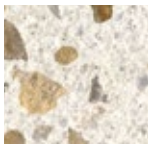

\*SSP-510  
\*\*70

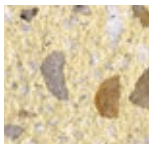

\*SSP-520  
\*\*70

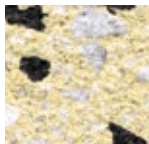

\*SSP-530  
\*\*63



\*SSP-540  
\*\*60

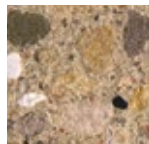

\*SSP-550  
\*\*48

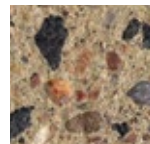

\*SSP-560  
\*\*40



\*SSP-570  
\*\*42

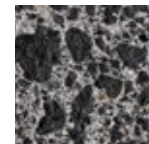

\*SSP-580  
\*\*26



\*SSP-590  
\*\*33

Pavers available in thickness ranging from 2" - 2 7/8" depending on the size.

\*Unsealed

## STONEY CREEK

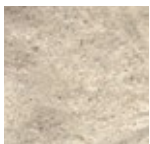

\*SC-10  
\*\*50

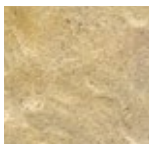

\*SC-20  
\*\*35

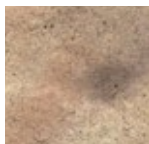

\*SC-30  
\*\*38



\*SC-40

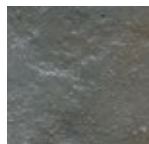

\*SC-50



\*SC-60

\*Sealed

## TEXTURED GRANITE

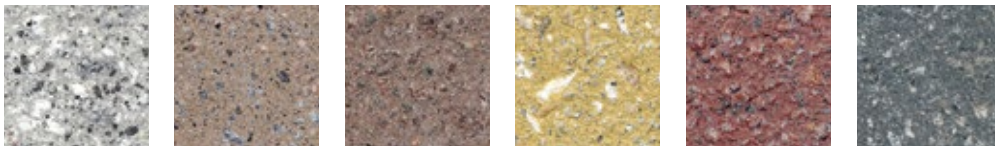

UG-10  
\*\*39

UG-20  
\*\*30

UG-30  
\*\*20

UG-40  
\*\*44

UG-50  
\*\*25

UG-60  
\*\*12

## TIMBER

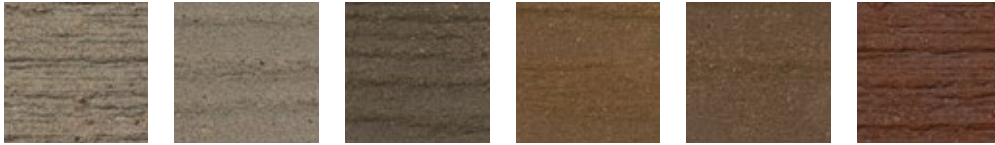

TB-10

TB-15

TB-30

TB-40

TB-45

TB-50

## ULTRAFACE



UF-15  
\*\*78

UF-20  
\*\*43

UF-25  
\*\*56

UF-30  
\*\*27

UF-35  
\*\*29

UF-40  
\*\*27

UF-50  
\*\*25

UF-60  
\*\*13

## LOK-DOWN INSTRUCTIONS

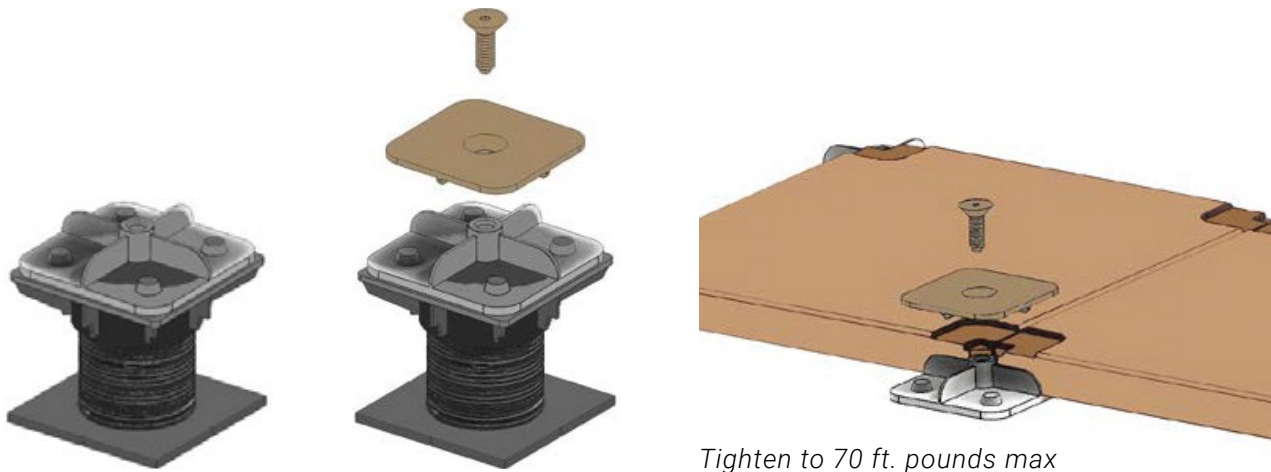

*Tighten to 70 ft. pounds max*

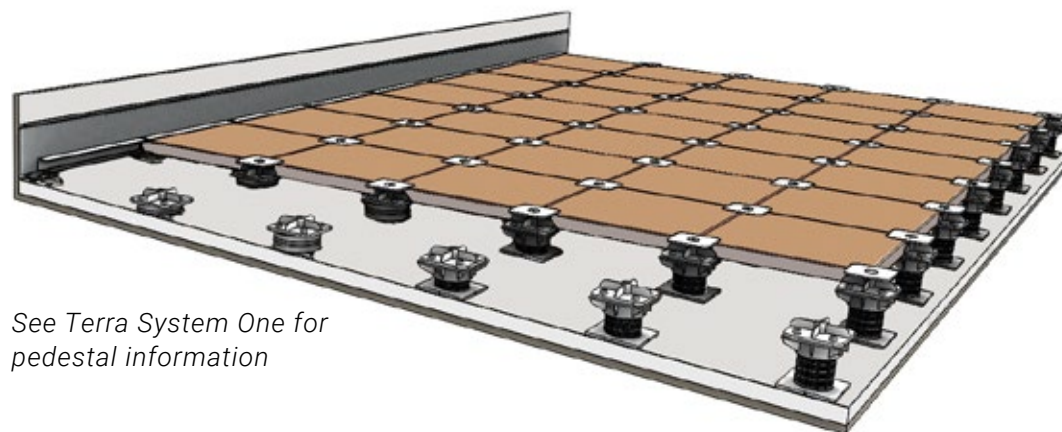

*See Terra System One for  
pedestal information*

# Maintaining Wausau Pavers

Wausau Tile pavers can be maintained to retain the attractive appearance and prolong the life of the pavers. When using maintenance materials, please follow the product manufacturer's instructions regarding the use of any equipment or cleaning materials described here. Be sure to angle the spray and limit the pressure, as not to damage the surface of the paver when using a pressure washer. For specific or unusual problems, please call us at 800-388-8728.

## Weekly Maintenance

Sweep or pressure wash deck. In areas of high traffic, such as doorways, daily cleaning may be required.

## Semiannual Maintenance (Spring and Fall)

Power sweep, then pressure wash total deck surface. Spot clean any stained areas using procedures described in "Cleaning Heavily Soiled Areas."

Remove pavers located over drains on open joint systems. Clean Debris from all drain covers to prevent plugging of drains and replace pavers.

Check pavers for rocking, low or high edges, joint spacing, alignment and broken or chipped pavers. If minor settling or movement has occurred, pavers can be leveled and adjusted with shims. Chipped or broken pavers should be replaced.

## Cleaning Heavily Soiled Areas

Soiled areas should be cleaned as soon as possible to avoid staining. The type of material causing the soiling determines the correct procedures.

### A. Oil or Petroleum Products

Remove as much of the material as possible with hot water high pressure washer. Apply degreaser cleaner directly to the soiled area. With a stiff nylon brush or broom, scrub the area. Rinse the area with hot water high pressure washer. In some cases, a second cleaning may be required.

### B. Rust Stains

Soak area with water. Scrub rust stains with masonry cleaner products per manufacturer's recommendations. (Be extremely careful around any metal surfaces). Rinse area thoroughly.

### C. Soiling from Normal Foot Traffic, Road Salts, Everyday Use

Wash area thoroughly with hot water high pressure washer. On heavily soiled areas, spray the area with a commercial grade cleaner and scrub with a nylon brush. Rinse thoroughly.

### D. Gum or Tar

Apply dry ice directly on top of the gum or tar. After freezing, use a putty knife or scraper to remove the gum or tar from the surface.

### E. Tobacco Stains on Light Colored Pavers

After pressure washing with hot water, saturate a paper towel with household bleach. Apply towel directly to stain and cover with minimum 3 mil poly. Tape poly to surface to hold in place. Leave stain covered for 24 to 48 hours. Remove to see if stain is gone or lightened. Repeat if necessary.

## **Snow Removal**

Snow can be cleaned from the deck using shovels, walk-behind snow blowers or power brushes. A four wheeled garden tractor, weight not exceeding 1,700 lbs. manned, can also be used. Nylon or rubber scrapers are recommended to avoid scratching of pavers. Tire chains can cause minor scratching and extra care should be taken with chains.

The use of snow melt materials should be minimal and in accordance with manufacturer's recommendations. Some types of snow melt are not recommended for use on new concrete and can cause surface damage to the paver.

## **Open Joint Installations**

Open joint installation is unique in that the pavers are elevated to allow water and air to flow through the joints of the pavers. It is essential that all the joints and all drains stay open, clean and free of dirt and debris. Failure to maintain clean joints may result in performance issues.

## **Efflorescence in Colored Pavers**

Efflorescence is a condition which appears as a white stain on some colored concrete and masonry products. It is a common occurrence in new concrete, created by sodium and sulfate compounds of several hydroxides, minerals, chlorides and nitrates which deposit on the surface and pores. It is the result of moisture evaporation and is most common on darker colored pavers and fabricated surfaces.

Water (rain, humidity, or ground water which "wicks") penetrates the pavers and dissolves latent salt. Sun draws the salt in solution to the surface and as moisture evaporates it is deposited on the surface. Efflorescence clears up as paver's age and eventually dissipates. The length of time varies with weather conditions and wear. Efflorescence can also be caused when salts in the sub-base material wick up around and through the pavers and joints and deposit on the paver surface and sides.

## **Wausau Tile Warranty**

Wausau Tile products are warranted to be free from defect in material and workmanship during manufacturing based on applicable industry standards. Warranty periods begin on delivery date of the warranted product and extend for the period listed below:

- Precast terrazzo products are warranted for two years.
- Terrazzo tile, plastic and metal pieces are warranted for one year.
- Framing and aluminum products are warranted for two years.
- Powder coating is warranted for two years.
- Thermo-plastic coating is warranted for five years.
- Concrete site furnishings are warranted for two years.
- Pavers are warranted for three years if properly installed according to both project specifications and Wausau Tile installation recommendations. Placing pavers on non-Wausau Tile pedestals voids this LIMITED WARRANTY.